



**Cartridge Maintenance/
Repair Guide**

**CHICAGO
FAUCETS**
Geberit Group

Thank you for choosing Chicago Faucets! All Chicago Faucets products are carefully assembled and tested to insure the highest quality in the plumbing industry. We are proud to offer you a product that will provide years of dependable, reliable service.

The Maintenance and Repair Guide is intended to provide you, as a customer, with step-by-step procedures for replacing or renewing our most popular cartridges. These procedures are limited to minor problems that are the result of normal wear and not intended to cover repairs that are the result of damage caused by abuse or vandalism.

Ceramic Cartridge Replacement	3
Renewing Quatern™ and Slow Compression Operating Cartridges	4
Renewing KLO-SELF™ Cartridges	5
Timing Adjustment of MVP™ Metering Valves	6
Renewing MVP Metering Valves	7
NAIAD™ Push Button Adjustment	8
Renewing NAIAD Cartridges	9
NAIAD Oscillating Cartridge Adjustment	10
Repair NAIAD Oscillating and Dashpot Cartridges	11
Replacement Cartridge Model Numbers	12
ECAST® Cartridges	13
Repair Kits	14 - 15

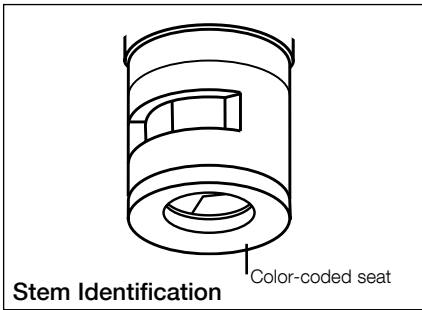

Stem Identification

Ensure cartridges are in the closed position before installing into valve body. Cartridges feature color-coded seats. Blue seat on cold cartridge, red seat on hot cartridge.

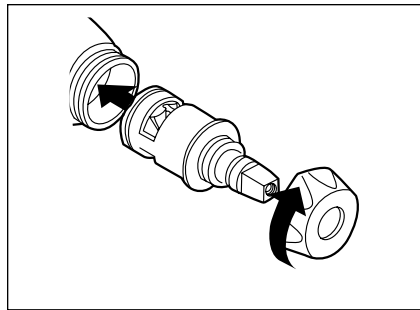

Step 1 Push each cartridge into valve body until it seats. Add cap nuts and hand tighten. Add handles.

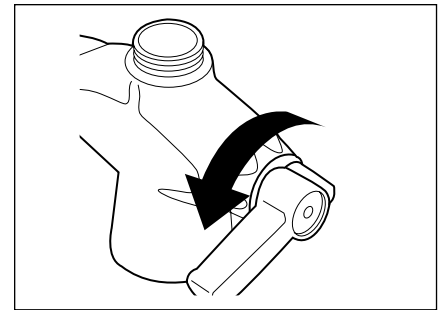

Step 2 Rotate RIGHT handle (and cartridge) counter clockwise to the desired closed position.

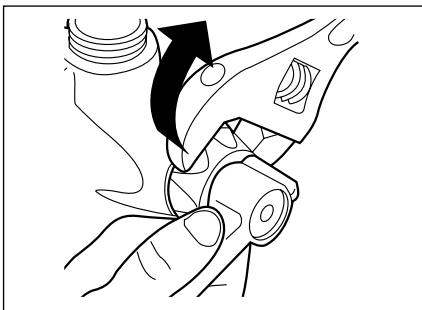

Step 3 Using handle to maintain stem position, fully tighten right cap nut to 20 to 27 ft. lb. torque.

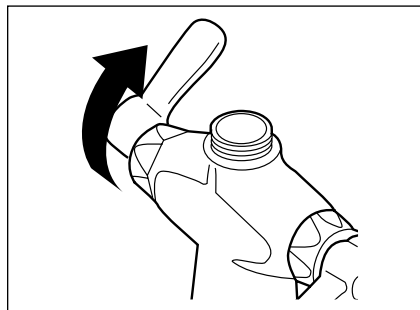

Step 4 Move LEFT handle (without moving cartridge) to the open position and fully tighten right cap nut to 20 to 27 ft. lb. torque. Return handle to closed position.

Ceramic Operating Cartridges

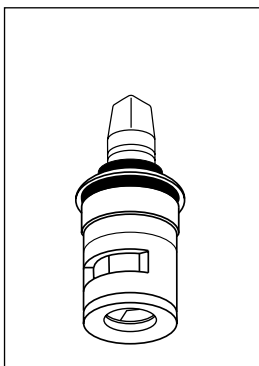

Short Stem*
No. 1-100XKJKABNF
Left Hand Cartridge
No. 1-099XKJKABNF
Right Hand Cartridge

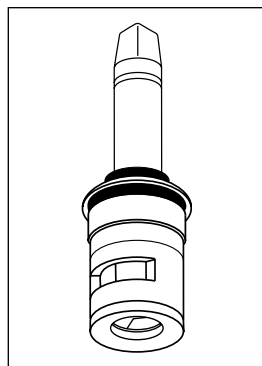

Long Stem*
No. 377-XKLHJKABNF
Left Hand Cartridge
No. 377-XKRHJKABNF
Right Hand Cartridge

Note: No replacement parts for ceramic cartridges, sold only as complete assembly.

*For ceramic cartridges with integral check valves, see page 12.

Renewing “XT” Quatum™ or Slow Compression Cartridges

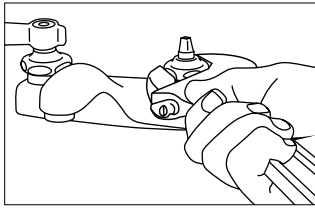

STEP 1 - Turn off water at stop or main valve. Remove handle assembly and with flat face wrench, remove cap nut (A).

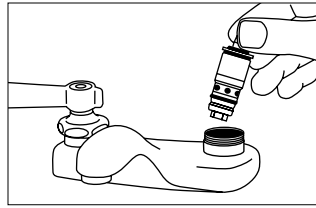

STEP 2 - Remove cartridge from faucet. Flush out any rust or chips that may be in body. **DO NOT** use file or abrasives to clean out body.

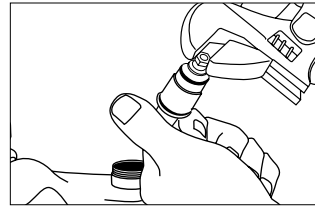

STEP 3 - Unscrew stem nut (K) at the bottom of the cartridge with a flat wrench using a handle as lever to assist removal.

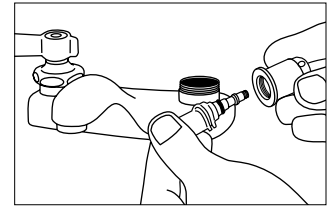

STEP 4 - Turn sleeve (D) off stem (C) by holding handle and turn sleeve by hand. As sleeve is removed from stem, seat (F) O-Ring (G) seat washer (H) retainer (I) and washer (J) will be forced off the stem.

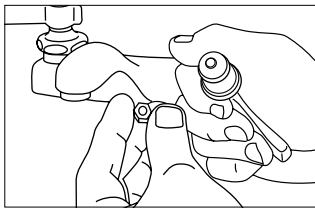

STEP 5 - Reassemble sleeve (D) on lightly lubricated stem (C). With new parts add seat (F) O-Ring (G) seat washer (H) retainer (I) and washer (J) on stem (C) and screw nut tightly on stem.

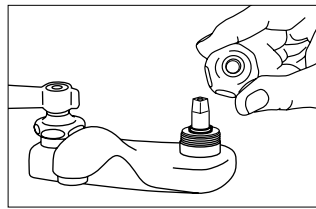

STEP 6 - Reposition washer and O-Ring (B) on stem (C) add to sleeve (D). Replace cartridge in faucet.

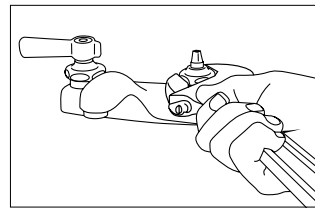

STEP 7 - Replace Cap Nut (A) and partially tighten. Replace handle and rotate cartridge in the direction of closing until the cartridge is in the desired position for convenient operation. Remove handle. Lock cartridge in place by securely tightening Cap Nut (A) to 20 - 27 ft. lbs torque.

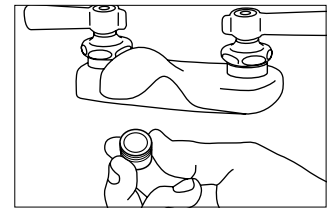

STEP 8 - Turn water on at main valve or stop. Remove outlet. Turn faucet on to “full” allowing sediment to flush from lines and replace aerator cartridge.

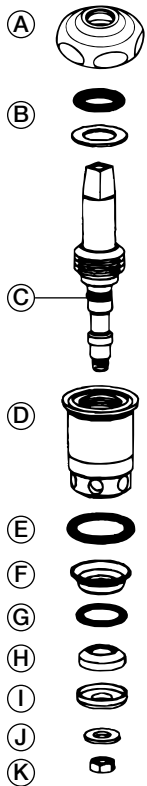

“XT” TYPE CARTRIDGES

PARTS LIST - Those parts listed in the “Description” column below that are marked with an asterisk (*) are parts that are recommended for replacement when renewing these operating cartridges. Other parts not marked may require replacement depending on the amount of wear they have received and their condition when examined. Most of the parts listed below are also available in multi-packs (box lots). See chicagofaucets.com or call Chicago Faucets Customer Service for more information. Note: items without a listed part number are not available to purchase separately.

Description	Quatum Cartridges				Slow Compression Cartridges			
	Exposed Cap		Concealed Cap		Exposed Cap		Concealed Cap	
Description	1-009XTJKABNF	1-100XTJKABNF	377-XTRHJKABNF	377-XTLHJKABNF	217-XTLHJKABNF	217-XTRHJKABNF	274-XTLHJKABNF	274-XTRHJKABNF
A. Cap	1-214JKCP	1-214JKCP	274-004JKRBF	274-004JKRBF	1-214JKCP	1-214JKCP	274-004JKRBF	274-004JKRBF
B. Packing Assembly*	93-131JKABNF	93-131JKABNF	93-131JKABNF	93-131JKABNF	93-131JKABNF	93-131JKABNF	93-131JKABNF	93-131JKABNF
C. Stem O-Ring	1-219JKABNF	1-219JKABNF	1-219JKABNF	1-219JKABNF	1-219JKABNF	1-219JKABNF	1-219JKABNF	1-219JKABNF
D. Sleeve	2-329JKABRBF	2-328JKABRBF	2-329JKABRBF	2-328JKABRBF	317-102JKABRBF	317-103JKABRBF	317-102JKABRBF	317-103JKABRBF
E. O-Ring	2-043JKABNF	2-043JKABNF	2-043JKABNF	2-043JKABNF	2-043JKABNF	2-043JKABNF	2-043JKABNF	2-043JKABNF
F. Seat*	1-327JKABNF	1-327JKABNF	1-327JKABNF	1-327JKABNF	1-327JKABNF	1-327JKABNF	1-327JKABNF	1-327JKABNF
G. O-Ring	1-328JKABNF	1-328JKABNF	1-328JKABNF	1-328JKABNF	1-328JKABNF	1-328JKABNF	1-328JKABNF	1-328JKABNF
H. Seat Washer*	1-021JKABNF	1-021JKABNF	1-021JKABNF	1-021JKABNF	1-021JKABNF	1-021JKABNF	1-021JKABNF	1-021JKABNF
I. Retainer	1-022JKABNF	1-022JKABNF	1-022JKABNF	1-022JKABNF	1-022JKABNF	1-022JKABNF	1-022JKABNF	1-022JKABNF
J. Washer	1-031JKABNF	1-031JKABNF	1-031JKABNF	1-031JKABNF	1-031JKABNF	1-031JKABNF	1-031JKABNF	1-031JKABNF
K. Nut	333-097JKABNF	333-097JKABNF	333-097JKABNF	333-097JKABNF	333-097JKABNF	333-097JKABNF	333-097JKABNF	333-097JKABNF

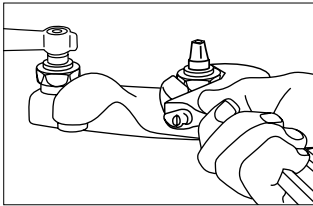

STEP 1 - Turn off water at stop or main valve. Remove handle, loosen cap nut (A) with flat faced wrench and remove upper parts of cartridge consisting of stem (C), bonnet (B) and spring (D).

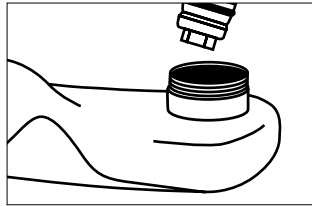

STEP 2 - With pliers, grab the cartridge stem and pull up, removing it from the body.

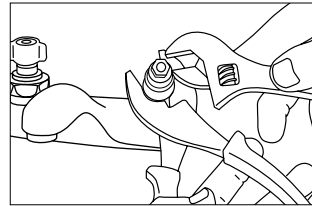

STEP 3 - Holding the flat portion of plunger (E) remove stem nut (P). After stem nut is removed, remove washer (O), retainer (N) seat washer (M) and Monel seat (L) by tapping bottom of plunger until parts are loosened. Now, remove O-Rings (H), leather packing (I), gland (G) and spring (F) from sleeve (K).

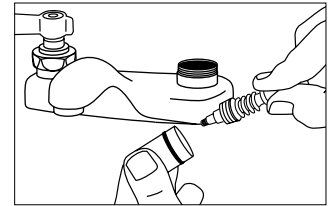

STEP 4 - To reassemble, clean any lime or foreign matter that may have built-up on parts. Lubricate plunger surface (E) and place spring (F) and gland (G) on plunger. Replace the (2) O-Rings (H) making sure that the leather packing is placed between them. Slide O-Rings and leather packing on the plunger. Lubricate O-Rings and leather packing with a light grease before the plunger is inserted into the sleeve (K).

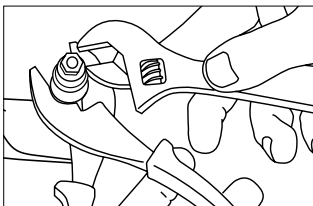

STEP 5 - Replace Monel seat (L), seat washer (M), retainer (N), cup washer (O), and tighten nut (P) securely.

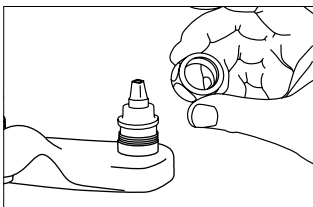

STEP 6 - Replace O-Ring (J) with new O-Ring, inserting into groove on the sleeve (K). Lubricate outside of O-Ring, stem (C) and inside of bonnet (B). Lubricate spring (D) and insert into stem. Assemble upper parts of cartridge (B,C,D) and tighten nut (A) to faucet body sufficiently (25 - 32 ft. lbs.) to insure that metal to metal contact of lower seat (L) in faucet body. Bonnet and sleeve must also make metal to metal contact. Replace handle.

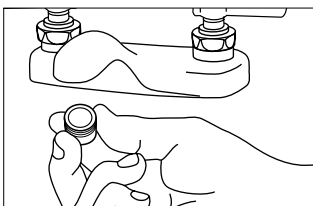

STEP 7 - Turn water on at stop or main valve. Remove aerator. Turn faucet on to "full" allowing sediment to flush from lines and replace aerator cartridge.

826-XJKABNF Parts Overview

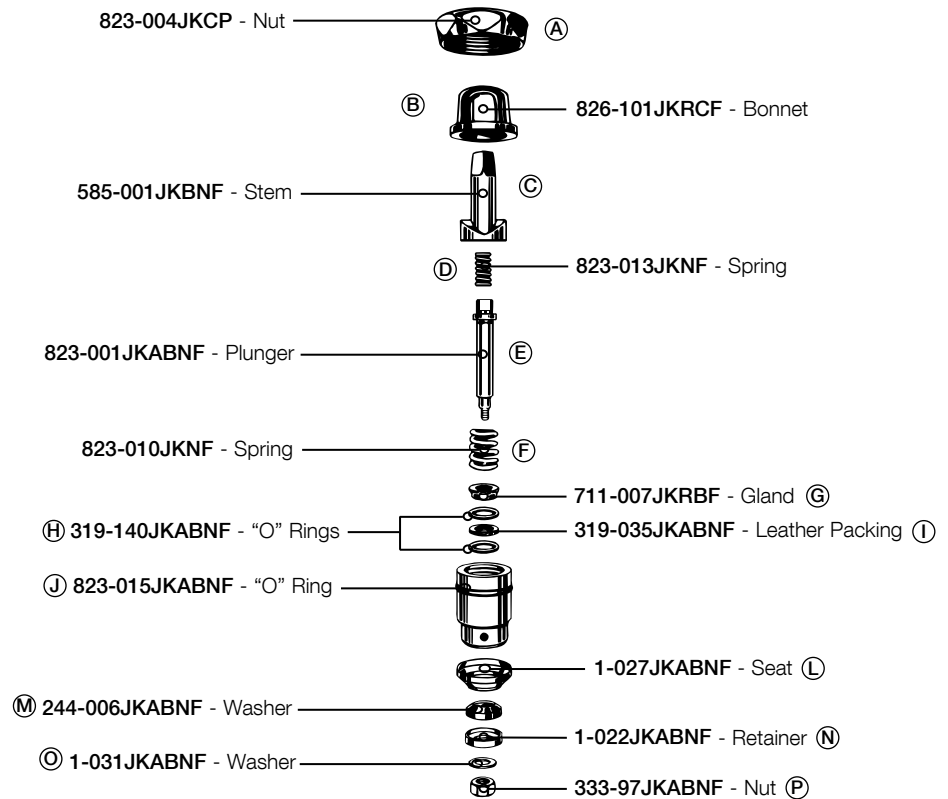

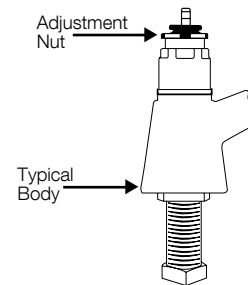
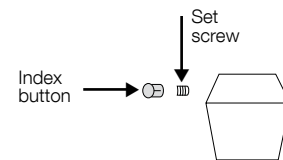
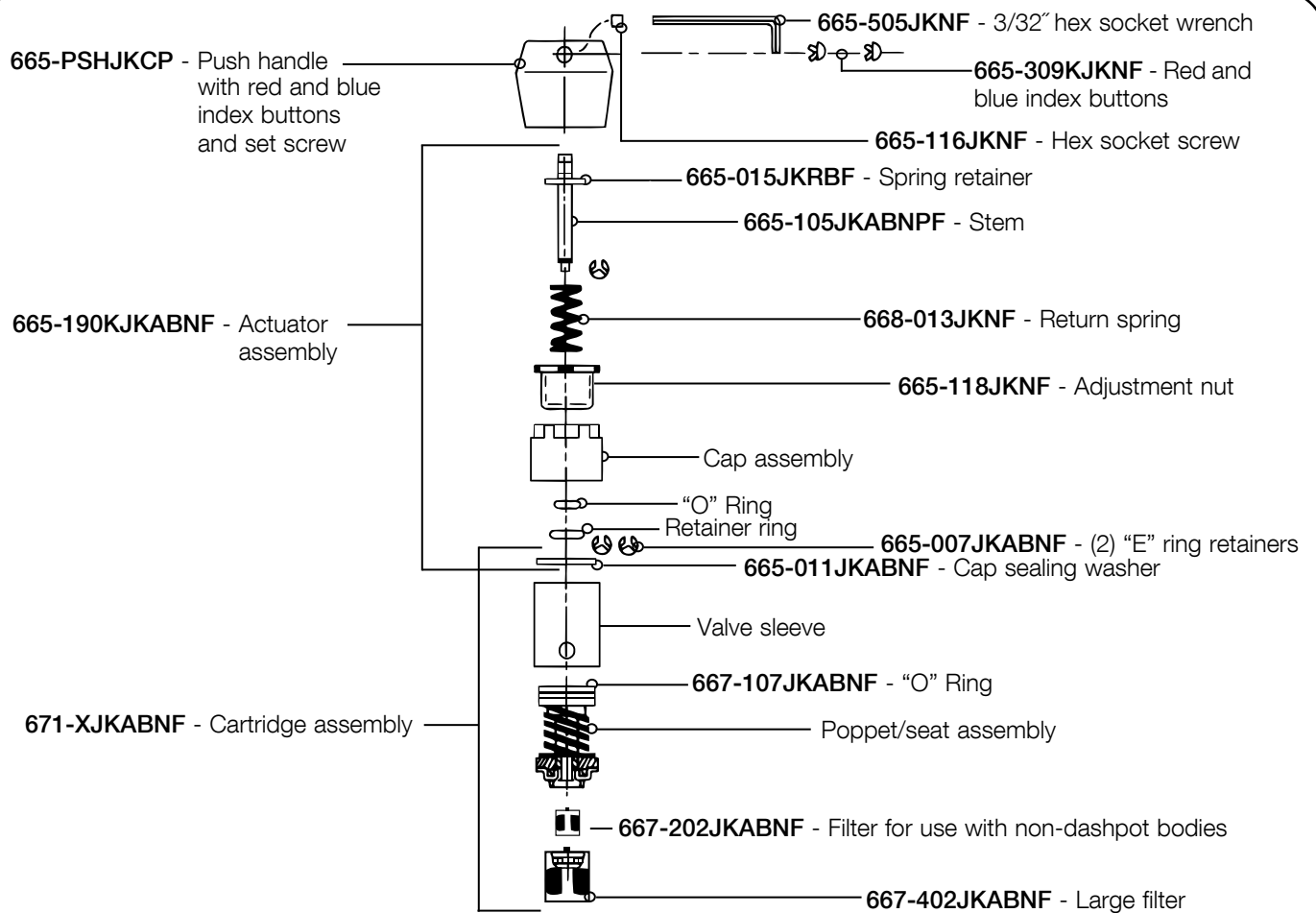

Timing Adjustment on an MVP Metering Cartridge

- ① With handle in place, purge cartridge of air by pushing completely down 4-8 times rapidly, then check timing cycle.
- ② Remove handle with a 3/32 allen wrench.
- ③ Use a standard pair of pliers (other tools may damage the adjustment nut) to change height of adjustment nut by 1/4 turn only. Turn adjustment nut clockwise to increase time.
- ④ Replace handle and time flow. NOTE: TIMING MUST BE CHECKED WITH HANDLE IN PLACE
- ⑤ If more adjustment is needed, follow steps 3 and 4 until timing is right.
- ⑥ Attach handle and tighten screw. Press index button into handle opening.

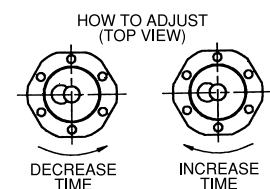

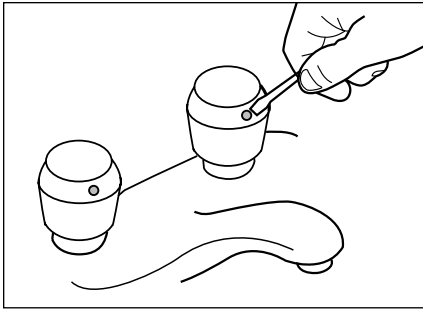

Step 1 Remove color coded index button from handle with small, flathead screwdriver.

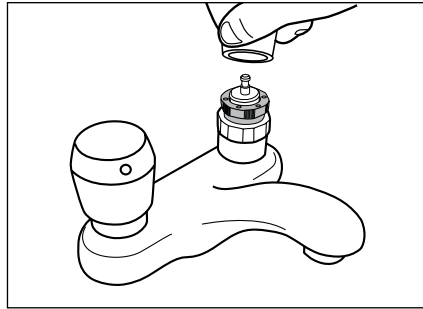

Step 2 Insert 3/32" allen wrench in handle hole, loosen allen screw and remove handle.

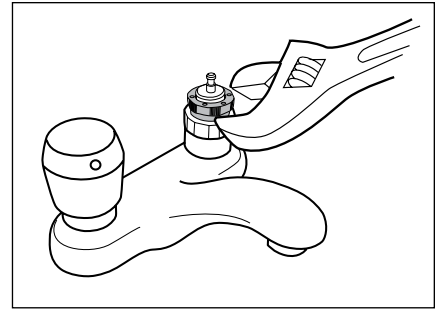

Step 3 To adjust the flow cycle of the MVP valve, turn the adjustment nut clockwise to increase the duration of the flow cycle and counter clockwise to decrease the flow cycle.

*After adjustment nut has been repositioned, replace handle, push down and test flow cycle.**

See page 6 for additional timing adjustment.

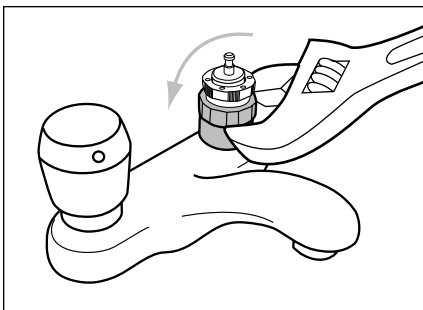

Step 4 If MVP cartridge is to be replaced, **TURN OFF WATER SUPPLY BEFORE PROCEEDING.** Using a wrench, remove actuator assembly.

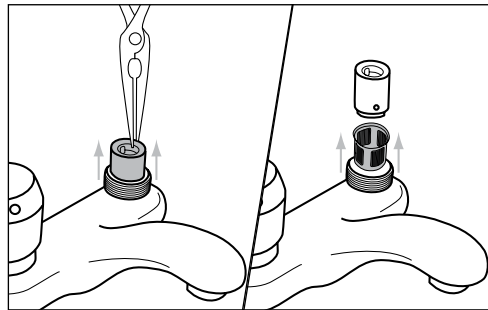

Step 5 Grasp cartridge valve top with needle-nose pliers, remove MVP cartridge from valve body. Remove filter screen from inside of body with finger tip.

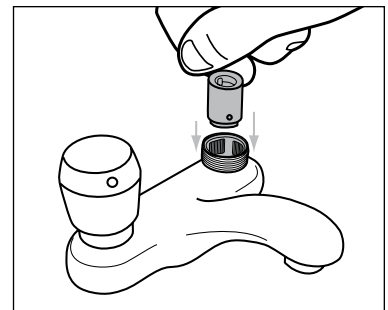

Step 6 Place new filter screen and MVP cartridge in valve body.

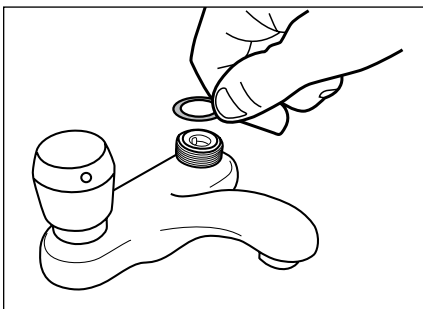

Step 7 and 8 Replace cap sealing washer and actuator assembly. (Adjust flow cycle as described in #3.) Do not over tighten cap.

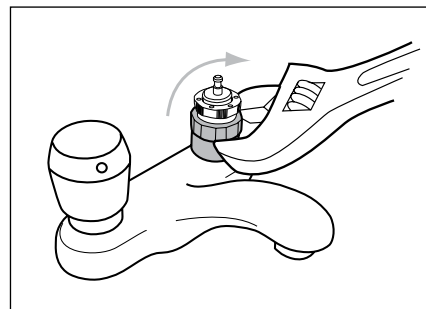

Step 9 Replace handle, tighten handle nut with allen wrench and replace index button.

* While the adjustment nut can be hand adjusted, you may have to start the adjustment by using a wrench or pliers. It is important to grip the adjustment nut loosely so as not to deform or damage the nut.

** To properly test the flow cycle, the valve handle must be in place and actuated.

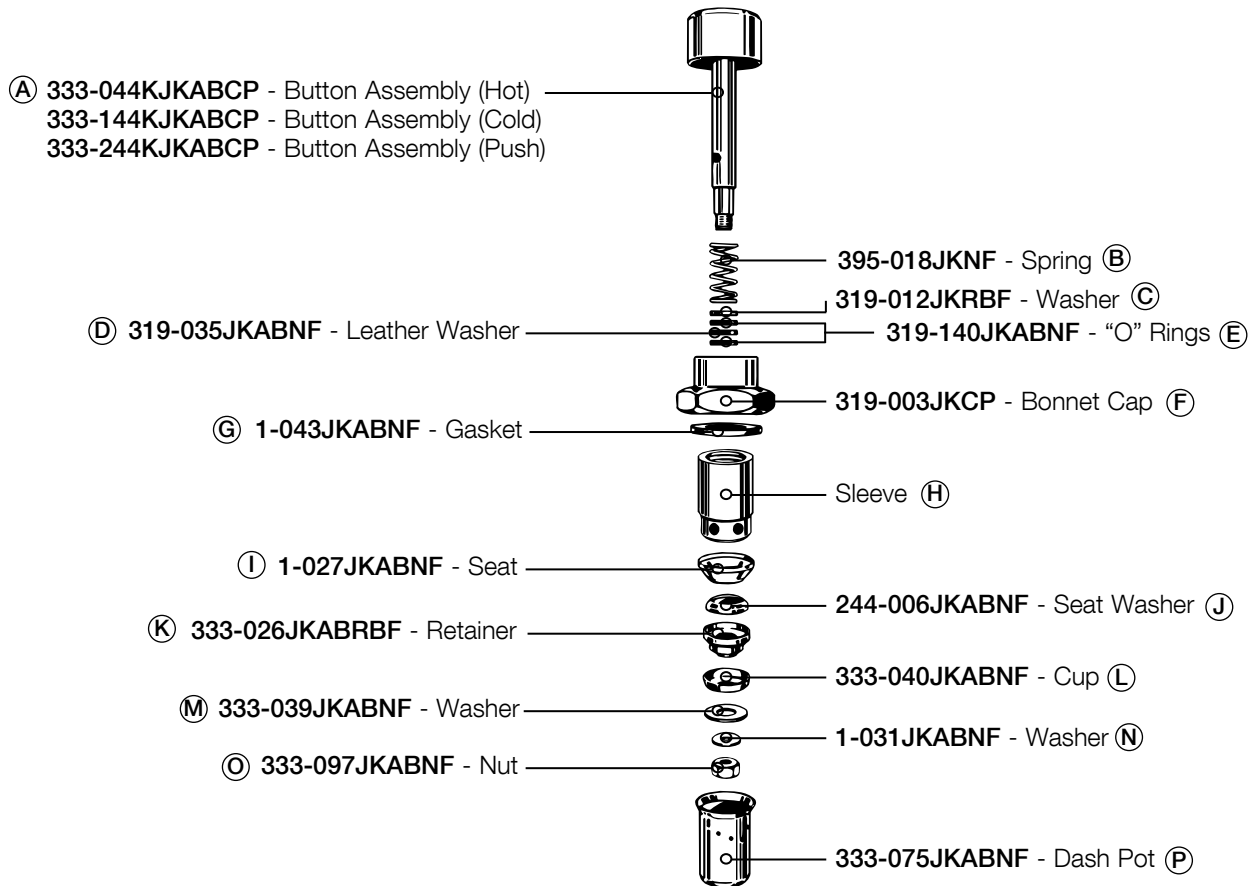

No. 333-X NAIAD is used for all No. 333 Basin faucets and all push button stops and contains a fast closing dashpot. Note: 333-XSLO is the same as No. 333-X, but with an additional external timing feature located on the button and a 333-073KJKNF adjustable slow closing dashpot.

No. 625-X NAIAD operating cartridge is used for all pedal valves. Except for the 625 and 628 on which the 628X one hole sleeve operating cartridge is used.

An adjustable slow closing model is available for both the 625-X and 628-X, which includes the 333-073KJKNF dashpot and is designated by 625-XSLO and 628-XSLO.

Timing Adjustment on a NAIAD Push Button Slo-Closing Cartridge

Timing can be changed by adjusting the nut located at the lower end of the dashpot.

Shorter running time = LOOSEN (counter clockwise)

Longer running time = TIGHTEN (clockwise)

Note: Do not over tighten adjustment nut as it may cause continual run-on of faucet.

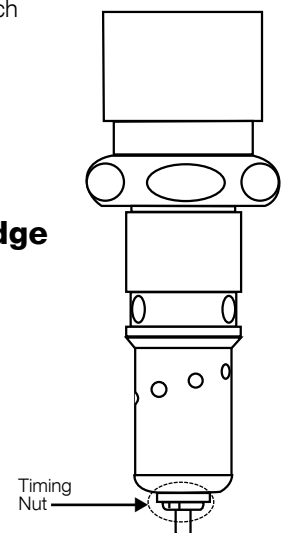

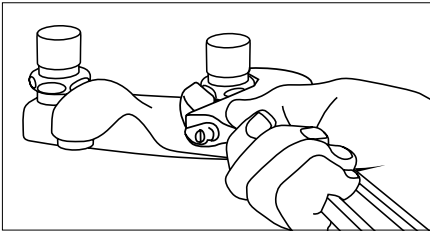

STEP 1 - Turn off water at stop or main valve. Loosen bonnet cap (F) with flat faced wrench and remove operating cartridge from valve body. Remove the dashpot (P) from the body.

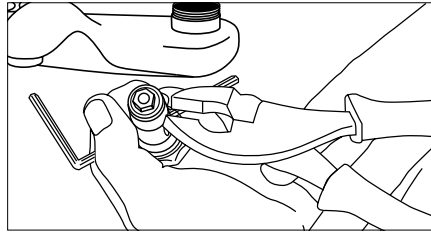

STEP 2 - To disassemble cartridge, insert pin through hole in sleeve (H) and stem (A) to keep stem from turning while nut (O) is removed. (Same procedure is followed when assembling operating cartridge.)

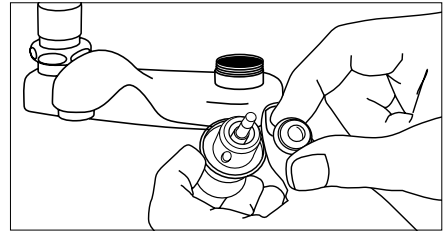

STEP 3 - Remove washer (N), washer (M), cup (L), retainer (K), washer (J) and seat (I) from stem. If leakage is occurring through spout outlet, replace seat (I) and seat washer (J). Replace cup (L), washer (M) and washer (N) as necessary.

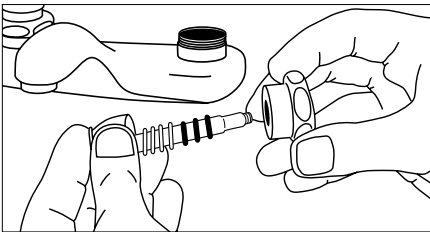

STEP 4 - If water leakage is occurring around the button assembly, remove button and stem assembly (A) from sleeve (H) and bonnet cap (F). Clean stem thoroughly and lubricate top half with grease. Remove O-Rings (E) and washer (C and D) from cap (F). Replace the packing arrangement on stem assembly (A) by sliding washer (C) on stem and then leather washer (D) between the two O-Rings (E) onto the stem. Next slide cap (F) onto stem (A) and firmly slide cap up the stem to allow spring (B) to seat O-Rings and washers in cap (F).

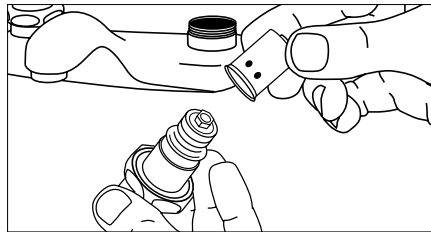

STEP 5 - Reassemble lower portion of cartridge by sliding sleeve (H), seat (I), washer (J), retainer (K), cup (L), washers (M and N) and nut (O) in the same manner as described in Step 2. Lightly grease exterior of cup (L). Tighten nut (O) securely on stem using pin through sleeve (H) and button assembly (A) to contain assembly while tightening. Remove pin when complete. Reposition dash pot (P) on cartridge.

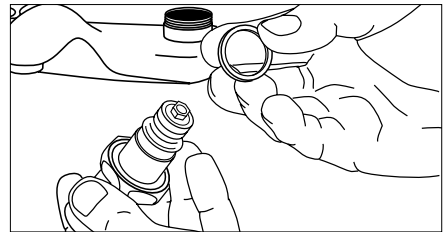

STEP 6 - Replace gasket (G) before placing cartridge in valve body. Be sure gasket (G) is around sleeve (H) before tightening cap (F) to valve body. Turn water on at stop or main valve. Remove aerator. Turn faucet on to "full" allowing sediment to flush from lines and operating cartridge. Replace aerator.

STEP 7 - See page 8 for dashpot timing of Slo-Closing cartridges.

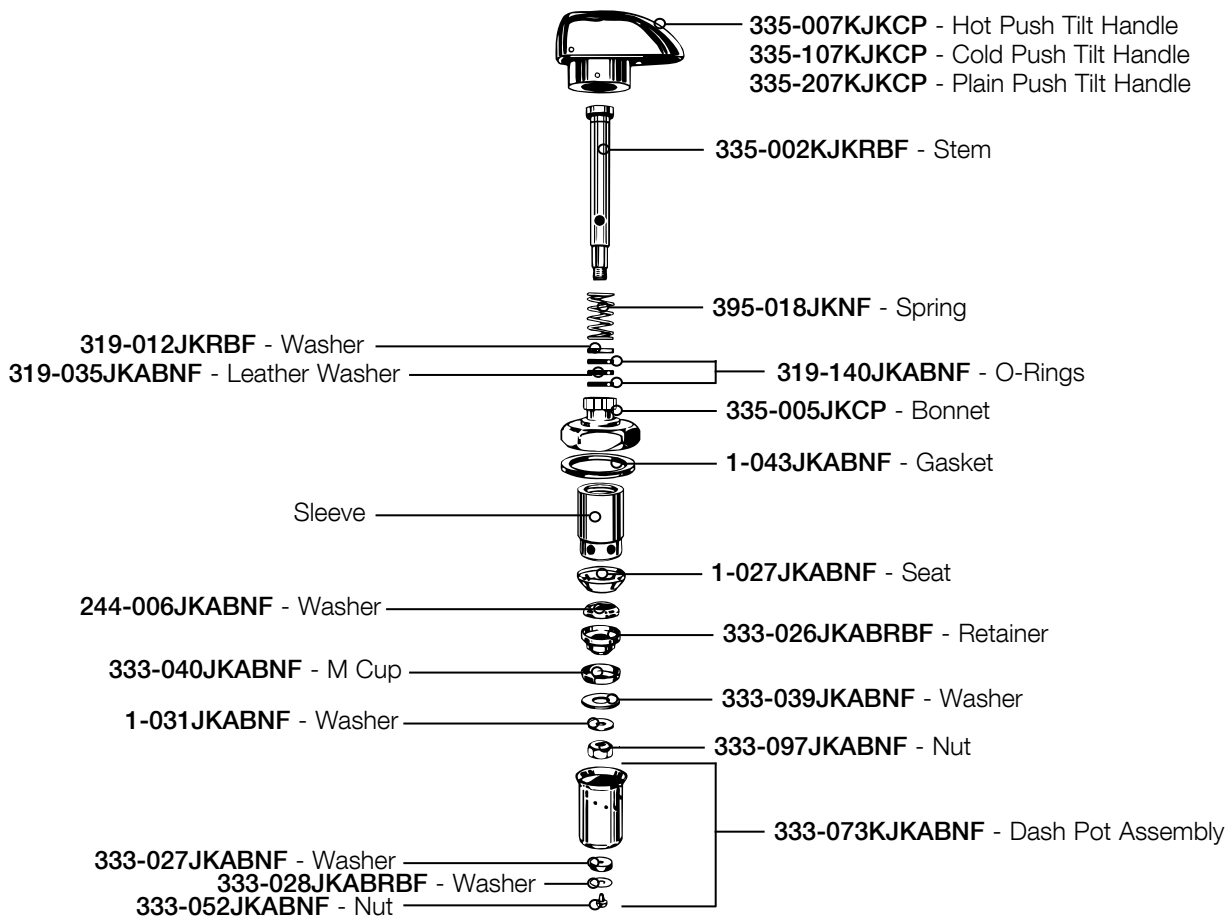

NOTE: See page 9 for disassembly and reassembly of cartridge when renewing components.

Repair Parts Kits

Part No.	Description
333-073KJKABNF	Dash Pot Assembly (Adjustable)

Timing Adjustment on a NAIAD Tip-Tap Slo-Closing Cartridge

We have two adjustments featured on the Tip-Tap Cartridge.

For dashpot adjustments follow step 1.

For handle adjustment follow steps 2-3.

- ① By tightening or loosening the 333-052 nut on the lower end of the dashpot, timing adjustment is made. (**Tightening increases running time.** It is suggested that the thickness of the felt washer be approximately 1/16" to 3/32" thick after tightening. This will deliver approximately 6-10 seconds timing. **Loosening decreases running time.**)
- ② Raise up front of tilt-handle to expose screw B. (use #6 allen key)
- ③ Set screw B adjusted all the way in gives maximum running time. Adjust set screw B out counter-clockwise for less running time.

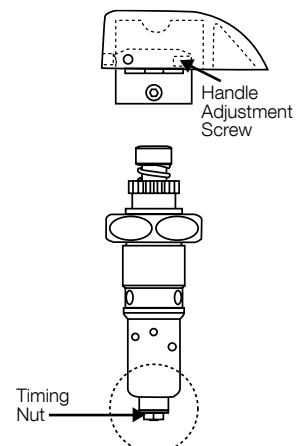

1. To uncover operating cartridges on 386-XSLO urinal valves with non-sag handles, unscrew bonnet (17) and remove entire assembly (23), on self-closing stops as shown on diagram below. For 386-X, remove bonnet (24) and handle (19).
2. Shut-off water at main or supply valve if installed.
3. Either cartridge can now be removed from body by loosening cap (6) with a flat wrench and lifting entire cartridge from body including the dashpot.
4. If leakage is occurring through spout outlet, insert 1/8" diameter pin or pin wrench through hole in stem and with crescent wrench remove stem nut (15) and all parts up to and including (9) seat. Inspect seat washer (10) and replace if necessary, next inspect seat (9) for nicks or water cutting and replace if necessary. If cup washer (12) has been sticking in dashpot, replace also.
5. If cartridge has been leaking between oscillating lever and upper cap, remove stem assembly (1) and spring (2) from sleeve (8) and cap (6) by taking out washer (3) from cap, take out packing arrangement which consists of (2) O-Rings (4) with leather washer (5) between O-Rings. Grease stem lightly around packing area and put new O-Rings and packing on stem using same arrangement as indicated, also lubricate O. D. of packing.
6. Place stem with spring, washer and packing properly assembled back into cap and sleeve. Now assemble lower cartridge parts in proper relation and insert pin or pin wrench in stem hole again and tighten nut (15). Grease cup (12) with light grease and place cartridge in dashpot.
7. We recommend removing and replacing (7) gasket before cartridge is placed in valve body. Place cartridge in body and lock cartridge by tightening cap (6) securely, add oscillating lever bonnet sub-assembly to cartridge.

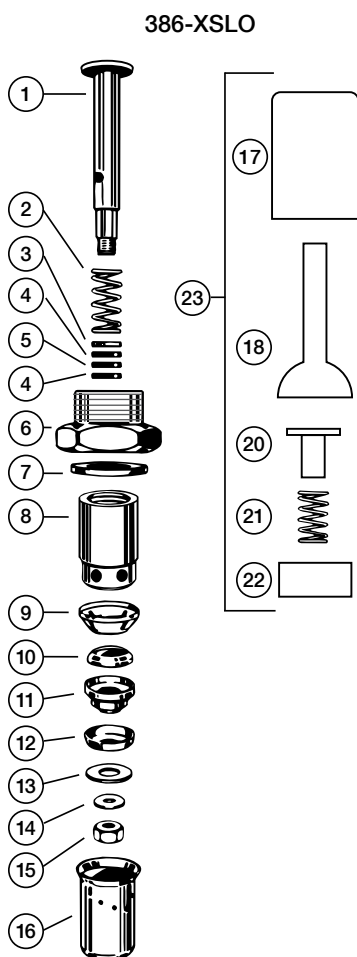

NOTE: Complete assembly of 386-XSLO cartridge and 386-010K Oscillating Lever Handle assembly for Urinal Valves.

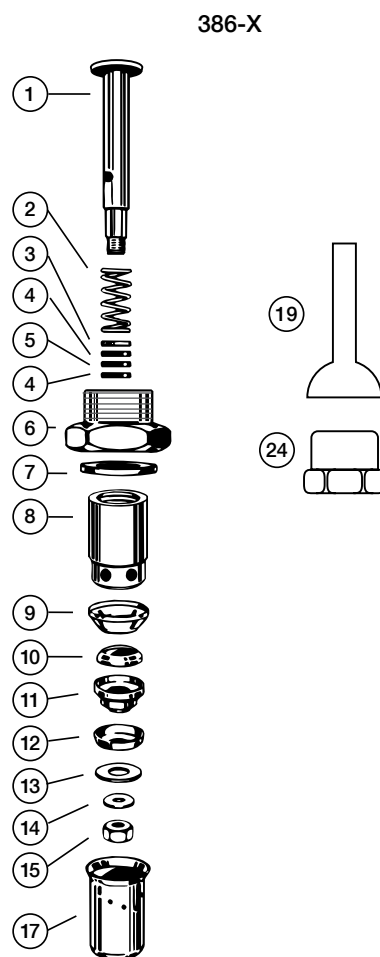

NOTE: Complete assembly of 386-X unit and Oscillating Lever and Bonnet for Self-Closing Stops.

Item No.	Part No.	Description
1	386-008KJKRBF	Button and Stem Assembly
2	395-018JKNF	Spring
3	319-012JKRBF	Brass Washer
4	319-140JKABNF	O-Ring
5	319-035JKABNF	Leather Washer
6	618-001JKCP	Cap Nut
7	1-043JKABNF	Gasket
8	-	Sleeve
9	1-027JKABNF	Monel Seat
10	244-006JKABNF	Rubber Seat Washer
11	333-026JKABRBF	Retainer
12	333-040JKABNF	Rubber Washer
13	333-039JKABNF	Washer
14	1-031JKABNF	Stem Washer
15	333-097JKABNF	Stem Nut
16	333-073KJKABNF	Slow Dashpot Assembly
17	333-075KJKABNF	Slow Dashpot Assembly
18	386-010JKCP	Bonnet
19	386-009JKCP	Ball Handle
20	386-011JKCP	Plunger
21	386-013JKNF	Spring
22	386-014JKRBF	Sleeve
23	386-010KJKCP	Handle Assembly
24	386-005JKCP	Bonnet

Quatern™ Compression Cartridge

- Opens and closes in just a 1/4 turn
- Unique design closes with water pressure
- Standard in all centerset and widespread faucets for sink and lavatory
- ADA Compliant when used with lever or wing handles
- Renewable parts available

Product No.	Description
1-099-245JKABNF	Exposed Cap, Short Stem, Right Hand Control-A-Flo
1-099STJKNF	Steam Cartridge
1-099XTJKABNF	Exposed Cap, Short Stem, Right Hand
1-099XTJKSPF	Exposed Cap, Short Stem, Right Hand, Silver Plate Finish
1-099XTJKTPF	Exposed Cap, Short Stem, Right Hand, Tin Plate Finish
1-100-245JKABNF	Exposed Cap, Short Stem, Left Hand Control-A-Flo
1-100XTJKABNF	Exposed Cap Short Stem, Left Hand
1-100XTJKSPF	Exposed Cap, Short Stem, Left Hand, Silver Plate Finish
1-100XTJKTPF	Exposed Cap, Short Stem, Left Hand, Tin Plate Finish
1105-XLHJKABNF	Exposed Cap, Long Stem, Left Hand
1105-XRHJKABNF	Exposed Cap, Long Stem, Right Hand
377-X245LHJKABNF	Concealed Cap, Long Stem, Left Hand Control-A-Flo
377-X245RHJKABNF	Concealed Cap, Long Stem, Right Hand Control-A-Flo
377-XTLHJKABNF	Concealed Cap, Left Hand
377-XTRHJKABNF	Concealed Cap, Right Hand

Slow Compression Cartridge

- For finer adjustment of water volume
- Most common in laboratory fittings
- Requires 180-degree turn to open and close completely
- ADA Compliant when used with lever or wing handles

Product No.	Description
217-XMLHJKABNF	Exposed Cap, Left Hand, Short Stem, Metal to Metal
217-XMVCLHJKABNF	Exposed Cap, Left Hand, Short Stem, Metal to Metal, Volume Control
217-XTLHJKABNF	Exposed Cap, Left Hand, Short Stem
217-XTLHJKSPF	Exposed Cap, Left Hand, Short Stem, Silver Plate Finish
217-XTLHJKTPF	Exposed Cap, Left Hand, Short Stem, Tin Plate Finish
217-XTRHJKABNF	Exposed Cap, Right Hand, Short Stem
217-XTRHJKSPF	Exposed Cap, Right Hand, Short Stem, Silver Plate Finish
217-XTRHJKTPF	Exposed Cap, Right Hand, Short Stem, Tin Plate Finish
274-XTLHJKABNF	Concealed Cap, Left Hand, Long Stem
274-XTLHJKTPF	Concealed Cap, Left Hand, Long Stem, Tin Plate Finish
274-XTRHJKABNF	Concealed Cap, Right Hand, Long Stem
274-XTRHJKTPF	Concealed Cap, Right Hand, Long Stem, Tin Plate Finish
376-CXJKABNF	Slow Compression Cartridge with Integral Check Valve
828-111KJKNF	Needle Point Cartridge for Lab Use, Polypropylene
870-110KJKPVC	Needle Point Cartridge for Lab Use, Polyvinyl Chloride
937-XSTNF	Steam Cartridge
962-XJKNF	Needle Point Cartridge for Lab Use
962-XJKSAM	Needle Point Cartridge for Lab Use, Satin Antimicrobial Finish
966-XJKNF	Micro Needle Point/Brass Seat Cartridge for Lab Use
966-XSSJKNF	Micro Needle Point/Stainless Steel Seat Cartridge for Lab Use

KLO-SELF™ Self-Closing Vandal Resistant Cartridge

- Self-closing, closes upon release of the handle by the user

Product No.	Description
825-XJKABNF	For Concealed Cap Installations, Instant Closing
826-XJKABNF	For Exposed Cap Installations, Instant Closing
826-XJKSPF	For Concealed Cap Installations, Instant Closing, Silver Plate Finish
826-XJKTPF	For Concealed Cap Installations, Instant Closing, Tin Plate Finish

Ceramic Cartridge

- Positive 1/4 turn, eliminating handle travel
- Available as a substitute for the Quatern compression cartridge
- ADA Compliant when used with lever or wing handles

Product No.	Description
1-099XKCJKABNF	Exposed Cap Short Stem with Integral Check Valve, Right Hand
1-099XKJKABNF	Exposed Cap Short Stem, Right Hand
1-100XKCJKABNF	Exposed Cap Short Stem with Integral Check Valve, Left Hand
1-100XKJKABNF	Exposed Cap Short Stem, Left Hand
377-XKLHJKABNF	Concealed Cap, Long Stem, Left Hand
377-XKRHJKABNF	Concealed Cap, Long Stem, Right Hand
420-XJKABNF	For 420 Series Faucets
430-XJKABNF	For 430 Series Faucets
977-XKCLHJKABNF	Concealed Cap, Long Stem with Integral Check Valve, Left Hand
977-XKCRHJKABNF	Concealed Cap, Long Stem with Integral Check Valve, Right Hand
2300-XJKABNF	For Marathon Single Control Kitchen and Lavatory Faucets

Metering Self-Closing, Adjustable Cartridge

- Close either upon release or within a 2-15 second cycle time
- Helps reduce water usage in high traffic locations

Product No.	Description
NAIAD™ Cartridges	
333-XPSHJKABNF	Exposed Cap, Push Button, Immediate Closure
333-XCOLDJKABNF	Exposed Cap, Cold Button, Immediate Closure
333-XHOTJKABNF	Exposed Cap, Hot Button, Immediate Closure
333-XSLOCJKABNF	Exposed Cap, Cold Button, Adjustable Cycle Time
333-XSLOPJKABNF	Exposed Cap, Push Button, Adjustable Cycle Time
333-XSLOHOTJKABNF	Exposed Cap, Hot Button, Adjustable Cycle Time
335-XJKABNF	Exposed Cap "Tip-Tap" Cartridge, Adjustable Cycle Time
408-XPSHJKABNF	Exposed Cap, Push Button, Adjustable Cycle Time
409-XJKABNF	Exposed Cap "Tip-Tap" Cartridge, Adjustable Cycle Time
807-XPSHJKABNF	Exposed Cap, Push Button, Adjustable Cycle Time
Pedal Box Cartridges	
625-XJKABNF	Pedal Box Cartridge, No Index, High Flow Characteristics
628-XJKABNF	Pedal Box Cartridge, No Index, Low Flow Characteristics
625-XSLOJKABNF	Pedal Box Cartridge, No Index, Slow Closing
628-XSLOJKABNF	Pedal Box Cartridge, No Index, Slow Closing
628-XJKABTPF	Pedal Box Cartridge, No Index, Slow Closing, Tin Plate Finish
MVP™ Adjustable Timing Cartridges	
665-190KJKABNF	MVP Actuator Assembly
667-080KJKABNF	MVP Actuator Assembly and MVP Valve with Filter Screen
668-100KJKABNF	MVP Cartridge Rebuilding Kit
671-XJKABNF	MVP Valve with Filter Screen
672-XJKABNF	MVP Valve with Filter Screen, Immediate Closure
3300-003KJKABNF	MVP Cartridge for 3300 Series Faucets
3300-103KJKABNF	Actuator Assembly, Valve, Filter Screen for 3300 Series Faucets
Miscellaneous Cartridges	
313-XJKABNF	Glass Filler Cartridge
386-LEDXJKABNF	Glass Filler Cartridge, Less Dashpot
386-XSLOJKNF	Urinal Valve Cartridge
386-XSLOCJKNF	Urinal Valve Cartridge With Handle and Button Assembly
745-XJKABNF	Knee Valve Cartridge

ECAST®

How To Identify ECAST Cartridges

ECAST®, from Chicago Faucets, is the line of durable, high quality brass faucets and fittings that are designed and manufactured with less than one quarter of one percent (0.25%) total lead content by weighted average. These products are intended for installation in locations where federal law, state law, and local codes mandate lead content levels or wherever lead content is a concern.

In order to maintain the low-lead characteristics and certified status of your existing ECAST installations, it is critical that you identify and install the correct ECAST replacement parts. All replacement cartridges for ECAST products feature distinctive markings to make them easy to identify on the job site.



Replacement cartridges for existing ECAST installations feature two engraved rings around the top of the cartridge sleeve.

Repair Kit for Quatum™ and Slow Compression Operating Cartridges



Jiffy Repair Kit 1277-DAB	One Minute Repair Kit 1273-ABNF	Junior Repair Kit 1276-ABNF	Description	Part No.
-	3	1	Left Hand Stem (HOT)	-
-	3	1	Right Hand Stem (COLD)	-
-	1	-	Left Hand Long Stem	-
-	1	-	Right Hand Long Stem	-
-	2	-	Left Hand (HOT) Sleeves	-
-	2	-	Right Hand (COLD) Sleeves	-
4	100	50	Seat Washers	1-021JKNABF
-	25	3	Washer Retainers	1-022JKABNF
-	12	6	Stem Nut Washers	1-031JKNF
2	-	-	Gasket	1-043JKABNF
-	4	1	Complete Right Hand (COLD) Cartridges	1-099XTJKABNF
-	4	1	Complete Left hand (HOT) Cartridges	1-100XTJKABNF
-	4	2	Chrome Plated Caps	1-214JKCP
2	24	9	O-Rings	1-219JKABNF
-	50	25	Seats	1-327JKABNF
2	24	25	O-Rings	1-328JKABNF
2	48	9	O-Ring	1-519JKABNF
2	24	6	Cap Thread Gaskets	2-043JKABNF
-	1	-	Metal Box with Compartments	273-061JKNF
-	-	1	Metal Box with Compartments	276-060JKNF
4	12	6	Stem Nuts	333-097JKABNF
-	1	-	Complete Left Hand Long Stem Cartridge	377-XTLHJKABNF
-	1	-	Complete Right Hand Long Stem Cartridge	377-XTRHJKABNF
-	6	-	Handle Screws	420-010JKRCF
2	-	-	Brass Washers	93-031JKABRBF
2	24	9	Brass Washer	93-131JKABRBF

Repair Kit for KLO-SELF™ Type Cartridges



Jiffy Repair Kit 847-DAB	One Minute Repair Kit 883-ABNF	Junior Repair Kit 884-ABNF	Description	Part No.
-	4	-	Sleeves	-
-	25	15	Washer Retainers	1-022JKABNF
2	50	25	Seats	1-027JKABNF
-	16	6	Stem Nut Washers	1-031JKABNF
-	20	6	Cap Thread Gaskets	1-043JKABNF
2	100	25	Soft Seat Washers	244-006JKABNF
-	1	-	Metal Box with Compartments	273-061JKNF
-	-	1	Metal Box with Compartments	276-060JKNF
2	8	2	Leather Packing	319-035JKABNF
4	16	4	O-Rings	319-140JKABNF
-	18	6	Stem Nuts	333-097JKABNF
-	25	6	Handle Screws	420-010JKRCF
-	6	2	Stems	585-001JKBNF
-	12	2	Packing Glands	711-007JKRBF
-	12	2	Plungers	823-001JKNF
-	6	2	Cap Nuts, Chrome Plated	823-004JKCP
2	18	2	Springs	823-010JKNF
-	12	2	Springs	823-013JKNF
2	20	6	O-Rings	823-015JKABNF
-	6	2	Bonnets	826-101JKRCF

Repair Kit for NAIAD™ Push Button & Oscillating Handle Operating Cartridges



Jiffy Repair Kit 849-DAB	One Minute Repair Kit 820-ABNF	Junior Repair Kit 821-ABNF	Description	Part No.
—	2	—	Sleeves	—
2	12	6	Seats	1-027JKABNF
—	6	3	Stem Nut Washers	1-031JKABNF
2	20	6	Cap Thread Gaskets	1-043JKABNF
2	50	25	Soft Seat Washers	244-006JKABNF
—	2	1	Pin Wrenches	244-025JKNF
—	1	—	Metal Box with Compartments	273-061JKNF
—	—	1	Metal Box with Compartments	276-060JKNF
—	12	6	Brass Washers	319-012JKRBF
2	7	3	Leather Packing	319-035JKABNF
4	14	6	O-Rings	319-140JKABNF
—	12	4	Washer Retainers	333-026JKABRBF
—	12	6	Guide Washers	333-039JKABNF
2	20	10	Cup Washers	333-040JKABNF
—	4	—	Slow Dash Pot Assembly	333-073KJKABNF
—	4	2	Dashpot	333-075JKABNF
—	6	3	Stem Nuts	333-097JKABNF
—	4	2	Complete Naiad Cartridges	333-XPSHJKABNF
2	4	2	Springs	395-018JKNF

MVP™ Repair Kits

(See illustration on page 6 for details)

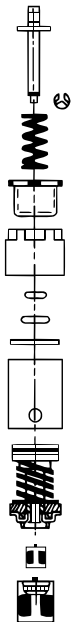

Part No.	Description
665-190KJKABNF	Actuator Assembly for Faucets with MVP Cartridge
667-080KJKABNF	One Each of Kits 665-190KJKABNF and 671-XJKABNF
668-100KJKABNF	(2) E Ring Retainer, Retainer Ring, Actuator O-Ring, Cartridge O-Ring, Cap Sealing Washer, Large Filter and Small Filter
671-XJKABNF	Metering Valve Unit
3300-003KJKABNF	Actuator Assembly for 3300 Series Faucets



We are a member of the U.S. Green Building Council and support the Leadership in Energy and Environmental Design (LEED) Green Building Rating System™, to measure the efficiency and sustainability of buildings in the U.S. and Canada. If you are trying to achieve LEED Certification for your building, our low-flow outlets, metering cartridges, and sensor-operated faucets can contribute points in these areas: Water Efficiency Credit 2: Innovative Wastewater Technologies and Water Efficiency Credit 3: Water Use Reduction.



We are proud to be a partner with WaterSense®, sponsored by the EPA and designed to protect the future of our nation's water supply by promoting efficiency and enhancing the market for water efficient products, programs, and practices.



We are a charter sponsor of the Alliance for Water Efficiency, a non-profit organization that is dedicated to the efficient and sustainable use of water. It brings together a diverse range of stakeholders to advocate water efficiency and conservation.

**CHICAGO
FAUCETS®**
Geberit Group

Chicago Faucets, a member of the Geberit Group, is the leading brand of commercial faucets and fittings in the United States, offering a complete range of products for schools, laboratories, hospitals, office buildings, food service, airports, and sports facilities. Whatever your requirements may be, Chicago Faucets offers standard and made-to-order products that are designed to meet any commercial application.

The Chicago Faucet Company
2100 South Clearwater Drive
Des Plaines, IL 60018
Phone: 847/803-5000
Fax: 847/803-5454
Technical: 800/832-8783
www.chicagofaucets.com